



## **GASOLINE BRUSH CUTTER & GRASS TRIMMER**

**RAC52PB-C**

**USER GUIDE**

**CAUTION:** Read this manual before using this machine!

# CONTENTS

1. SAFETY INSTRUCTIONS.....	3
2. YOUR PRODUCT.....	8
3. ASSEMBLY.....	10
4. OPERATION.....	11
5. MAINTENANCE AND STORAGE.....	19
6. TROUBLESHOOTING.....	21
7. DECLARATION OF CONFORMITY.....	23
8. WARRANTY.....	24
9. PRODUCT FAILURE.....	25
10. WARRANTY EXCLUSIONS.....	26

# 1. SAFETY INSTRUCTIONS

Proper safety precautions must be observed. Like all power equipment this unit must be handled carefully. **DO NOT EXPOSE YOURSELF OR OTHERS TO DANGER.**

Follow these general rules. Do not permit others to use this machine unless they are thoroughly responsible and have read, and understand the machine manual and are trained in its operation.

- Always wear safety goggles for eye protection. Dress properly; do not wear loose clothing or jewelry that could become caught in moving parts of the unit. Safe, sturdy, nonskid footwear should always be worn. Long hair should be tied back. It is recommended that legs and feet be covered to protect from flying debris during operation.
- Inspect the entire machine for loose parts (nuts, bolts, screws, etc.) and any damage. Repair or replace as necessary before using the machine. **DO NOT USE** any attachment with this power head other than the ones recommended by our company. Serious injury to the operator or bystanders could result as well as damage to the machine.
- Keep the handles free from oil and fuel.
- Always use proper handles and shoulder strap when cutting.
- Do not smoke while mixing fuel or filling tank.
- Do not mix fuel in an enclosed room or near open flames. Assure adequate ventilation.
- Always mix and store the fuel in a properly marked container that is approved by local codes and ordinances for such usage.
- Never remove the fuel tank cap while the engine is running.
- Never start or run the engine inside a closed room or building. Fumes from the exhaust contain dangerous carbon monoxide.
- Never attempt to make engine adjustments while the unit is running and strapped to the operator. Always make engine adjustments with the unit resting on a flat, clear surface.
- Do not use the unit if it is damaged or poorly adjusted. Never remove the machine's guard. Serious injury to the operator or bystanders could result as well as damage to the machine.
- Inspect the area to be cut and remove all debris that could become entangled in the nylon cutting head. Also remove any objects that the unit may throw during cutting.
- Keep children away. Onlookers should be kept at a safe distance from the work area, at least 15 meters (50 FEET).
- Never leave the machine unattended.
- Do not use this unit for any job other than those for which it is intended as described in this manual.
- Do not overreach. Keep proper footing and balance at all times. Do not run the unit while standing on a ladder or on any other unstable footing location.
- Keep hands and feet clear of the nylon cutting head or blade while unit is in use.
- Do not use this type of machine for sweeping away debris.
- Do not use the unit when you are tired, ill or under the influence of medication, drugs or alcohol.
- Use nylon cutting head which is free of damage. If a stone or any other obstacle is hit, stop the engine and check the nylon cutting head. A broken or unbalanced nylon cutting head must never be used.
- Do not store in a closed area where fuel vapors can reach an open flame from hot water heaters, furnaces, etc. Store in a locked, well-ventilated area only.
- Ensure safe and proper performance of your product. These parts are available from your dealer.

The use of any other accessories or attachments may cause a potential hazard or injury to the user, damage to the machine and void this warranty.

- Clean the machine completely, especially, the fuel tank, its surroundings, and the air cleaner.
- When refueling, be sure to stop the engine and confirm that it is cooled down.. Never refuel when the engine is running or hot. When gasoline spills, be sure to wipe it up completely dispose of those materials before starting the engine.
- Stay clear of other workers or bystanders by at least 15 meters/50 feet.
- Whenever approaching an operator of the machine, carefully call his attention and confirm that the operator stop the engine. Be careful not to startle or distract the operator which can cause an unsafe situation.
- Never touch the nylon cutting head or blade when ever the engine is running. If it is necessary to replace the protector or cutting attachment, be sure to stop the engine and confirm that the cutting device has stopped running.
- The engine should be turned off when the machine is moved between work areas
- Be careful not to hit the nylon cutting head against stones, or the ground.
- Unreasonable rough operation will shorten the life of the machine as well as create an unsafe environment for yourself and those around you.
- Pay attention to loosening and overheating of parts. If there is any abnormality of the machine, stop operation immediately and check the machine carefully. If necessary, have the machine serviced by an authorized dealer. Never continue to operate a machine which may be malfunctioning.
- In start-up or during operation of the engine, never touch hot parts such as the muffler, the high voltage wire or the spark plug.
- After the engine has stopped, the muffler is still hot. Never place the machine in any places where there are flammable materials (dry grass, etc.), combustible gasses or combustible liquids.
- Pay special attention to operation in the rain or just after the rain as the ground may be slippery.
- If you slip or fall to the ground or into a hole, release the throttle lever immediately.
- Be careful not to drop the machine or hit it against obstacles.
- Before proceeding to adjust or repair the machine, be sure to stop the engine and detach the spark plug.
- When the machine is placed in storage for a long time, drain fuel from the fuel tank and carburetor, clean the parts, move the machine to a safe place and confirm that the engine is cooled down.
- Make periodic inspections to assure safe and efficient operation. For a thorough inspection of your machine, please contact a dealer.
- Keep the machine away from fire or sparks.
- It is believed that a condition called Raynaud 's phenomenon, which affects the fingers of certain individuals, may be brought about by exposure to vibration and cold. loss of color and numbness in the fingers. The following precautions are strongly recommended because the minimum exposure which might trigger the ailment is unknown.
- Keep your body warm, especially the head, neck, feet, ankles, hands and wrists.
- Maintain good blood circulation by performing vigorous arm exercises during frequent work breaks and also by not smoking.
- Limit the hours of operation. Try to fill each day with jobs where operating the brush cutter or other hand-held power equipment is not required.

- If you experience discomfort, redness and swelling of the fingers followed by whitening and loss of feeling, consult your physician before further exposing yourself to cold and vibration.
- Always wear ear protection, loud noise for long time can make hearing debase even lost hearing.
- Total face and head protection must be wear to prevent damage from plummet or branch.
- Wear no-slip heavy duty work gloves to improve your grip on the brush cutter handle. Gloves also reduce the transmission of machine vibration to your hands.
- **WARNING:** The cutter area is still dangerous while the machine is coasting to a stop.
- When transport, this unit must be handled carefully. Do not expose yourself or others to danger.
- Envelop the blade before storage. Keep children away from it.
- Never remove the machine's guard.
- Do not store in a closed area where fuel vapors can reach an open flame from hot water heaters, furnaces, etc. Store in a locked, well-ventilated area only.
- Never place the machine in any places where there are flammable materials (dry grass, etc.), combustible gasses or combustible liquids.
- When the machine is placed in storage for a long time, drain fuel from the fuel tank and carburetor, clean the parts, move the machine to a safe place and confirm that the engine is cooled down.
- Warning - When operating the tool, be careful of the emission of exhaust gases, avoid being exposed to these and wear protective equipment.
- National regulation can restrict the use of the machine.
- Never modify a trimmer or cutter in any way.
- Improper use of the machine can cause **SERIOUS OR FATAL PERSONAL INJURY**.
- The engine exhaust from this product contains chemicals to cause cancer, birth defects, of other reproductive harm.
- Daily inspection before use and after dropping or other impacts to identify any significant defects.
- Improper maintenance can cause damage, accidents and render the tool inoperable in the short term.

### **Kickback and Related Warnings**

- Kickback is a sudden reaction to a pinched or snagged rotating wheel, backing pad, brush or any other accessory. Pinching or snagging causes rapid stalling of the rotating accessory which in turn causes the uncontrolled power tool to be forced in the direction opposite of the accessory's rotation at the point of the binding.
- For example, if an abrasive wheel is snagged or pinched by the workpiece, the edge of the wheel that is entering into the pinch point can dig into the surface of the material causing the wheel to climb out or kick out. The wheel may either jump toward or away from the operator, depending on direction of the wheel's movement at the point of pinching. Abrasive wheels may also break under these conditions.
- Kickback is the result of power tool misuse and/or incorrect operating procedures or conditions and can be avoided by taking proper precautions as given below.

**a) Never place your hand near the rotating accessory.** Accessory may kickback over your hand.

**b) Do not position your body in the area where power tool will move if kickback occurs.** Kickback will propel the tool in direction opposite to the wheel's movement at the point of snagging.

**c) Use special care when working corners, sharp edges etc. Avoid bouncing and snagging the accessory.** Corners, sharp edges or bouncing have a tendency to snag the rotating accessory and cause loss of control or kickback.

## **Residual risks**

Even if you use this product in accordance with all safety requirements, the potential risk of injury and damage remains. The following hazards may arise:

- There are harmful health consequences resulting from the emission of vibrations if the product is used for long periods of time or not managed adequately and properly maintained. The vibrations can produce the so-called "white finger" disease. If any of the symptoms of "white finger" syndrome appear, see a doctor immediately. Symptoms of the "white finger" include: numbness, loss of sensitivity, tickling, tingling, pain, loss of strength, color changes, or skin condition. These symptoms usually appear on the fingers, hands or wrists. The risk increases at low temperatures. To reduce this risk, please wear gloves and keep your hands warm. Limit the operating time.
- There is a risk of hearing loss during prolonged use, in particular if you do not wear hearing protection. Always wear hearing protection and limit the operating time.
- Cuts if no suitable protective clothing is worn.
- Inhalation of particles and exhaust gases if a mask of protection is not worn.
- Contact with projected objects.
- Burns when touching with hot surfaces.

## **Intended use**

This machine can be used as a trimmer with the cutting edges, and as a brushcutter with the cutting blade.

The grass trimmer must be strictly and only to cut grass or weeds that are not too dense. The brush cutter must be used to cut hard grass, more dense weeds, and small branches with a maximum diameter of 10mm.



This machine is not intended to cut bushes or others similar plants requiring the tool to get off the ground. Do not use this tool to work other materials such as stones, clay soils, etc.



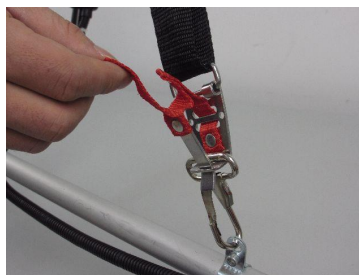







## **• OPERATION OF QUICK RELEASE MECHANISM**

Pull the strip to release the machine from you in the case of emergency.



## **Explanation of symbols**

	This graphic accompanied by the words <b>WARNING</b> and <b>DANGER</b> calls attention to an act of a condition which can lead to <b>SERIOUS INJURY</b> .
	<b>READ &amp; UNDERSTAND</b> Operator's Manual and Safety Manual

	<p>ALWAYS WEAR EYE PROTECTION, EAR PROTECTION AND HEAD PROTECTION.</p>
	<p>WEAR FOOT PROTECTION WEAR GLOVES</p>
	<p>BEWARE OF FALLING OBJECTS</p>
	<p>BEWARE OF FOOT INJURY BY CUTTING ATTACHMENT</p>
	<p>PAY ATTENTION THAT BYSTANDERS ARE NOT INJURED THROUGH FOREIGN OBJECTS THROWN FROM THE MACHINE.</p>
	<p>BEWARE OF THROWN OBJECTS HIT BY CUTTING ATTACHMENTS. NEVER USE WITHOUT PROPERLY MOUNTED BLADE GUARD. BEWARE OF BLADE THRUST.</p>
	<p>KEEP BYSTANDERS AT LEAST 15 M AWAY.</p>
	<p>DO NOT USE SAW BLADE.</p>
	<p>RISK OF HOT SURFACE</p>
	<p>GUARANTEE SOUND POWER LEVEL</p>

## 2. YOUR PROCUT

### a. Description



1. BLADE 3Z blade for grass, weed or brush cutting applications. Harness and plastic shield are required for blade operation
2. NYLON CUTTER HEAD Contains replaceable nylon trimming line that advances when the trimmer head is tapped against the ground while the head is turning at normal operating speed.
3. CUT-OFF KNIFE Trims nylon filament to the correct length-7", head to end of line-when nylon trimming head is bumped on the ground during operation, line advance. If trimmer is operated without a cut-off knife the line becomes too long (more than7") the engine, this will overheat or damage the engine.
4. DEBRIS SHIELD Mounted just above the cutting attachment. Helps protect operator by deflecting debris produced during debris produced during the trimming operation. Do not operate unit without shield.
5. HANDLE this handle can be adjusted at you convenience for comfort.
6. DRIVE SHAFT ASSEMBLY Contains a specially designed liner hard drive shaft.
7. IGNITION SWITCH "slide switch" mounted on top of the Throttle Trigger Housing. Move switch FORWARD to STOP, BACK to Run.
8. SAFETY LEVER Before acceleration, compress it please.
9. THROTTLE TRIGGER Spring loaded to return to idle when released. When accelerating, press trigger gradually for best operating technique. Do not hold trigger while starting.
10. PURGE BULB Pushing purge bulb (7 to 10 times before starting),will remove all air and sale fuel from fuel system and bring fresh fuel to the carburetor.
11. FUEL TANK LID.
12. FUEL TANK Contains fuel and fuel filter.
13. AIR CLEANER COVER Contains replaceable felt element.



14. CHOKE the choke control is located on the top of the filter cover.

15. STARTER HANDLE pull handle until engine starts, then return handle slowly. DO NOT let handle snap back or damage to starter will occur.

**b. Technical data**

MODEL	RAC52PB-C	
Main unit	Remote type	Centrifugal Clutch; Hard transmission
	Maximum speed of cutter head (r/min)	8,000
	Idle speed of engine(r/min)	3,000 ±200
	Centrifugal speed(r/min)	3,800
	Measured vibration emission value at each manipulation (m/s <sup>2</sup> ) (According to ISO 22867)	Brush cutter: - Left handle: 4.999 m/s <sup>2</sup> - Right handle: 3.755 m/s <sup>2</sup> Grass trimmer: - Left handle: 4.809 m/s <sup>2</sup> - Right handle: 5.110 m/s <sup>2</sup> , K=1.5 m/s <sup>2</sup>
	Measured sound pressure level LpA dB(A) (According to ISO 22868)	Brush cutter: 93 dB (A) Grass trimmer: 93 dB (A) K=3 dB (A)
	Measured sound power level LwA dB(A) (According to ISO 22868)	Brush cutter: 107 dB (A) Grass trimmer: 108 dB (A) K=3 dB (A)
	Guaranteed sound power level	115 dB (A)
	Line Max. Cutting Path /Diameter of line	44 cm(φ2.5mm, 7,500 min <sup>-1</sup> )
	Metal blade (Type/Diameter)	3-tooth Ø230xØ25.4x1.4mm, 8,000 min <sup>-1</sup>
	Rotation direction of cutting device	Counter-Clockwise (seen from the top)
	Type of aluminum pole	2 pieces
Weight when dry(kg)	7.3	
Engine	Name of engine	SPK44F
	Type	Air-cooled; 2 cycle; vertical Piston valve; gasoline engine
	Displacement( cm <sup>3</sup> )	52
	Maximum output(kW) (in accordance with ISO 8893)	1.3
	Maximum speed of engine (/min)	10,000
	Specific fuel consumption at max. engine performance (g/kWh)	≤695
	Carburetor	Diaphragm-type
	Ignition	Non-contact electronic ignition
	Method of starting	Recoil type
	Fuel used	Gasoline mixed with lubricating oil (ratio of 40:1)
	Fuel tank capacity( cm <sup>3</sup> )	1200

## 3. ASSEMBLY

### INSTALLING THE LOWER SHAFT

1. Pull the ring out, and then insert the attachment into the connector, make sure to fix the pin into the hole.
2. Tighten the knob bolt securely - clockwise direction.

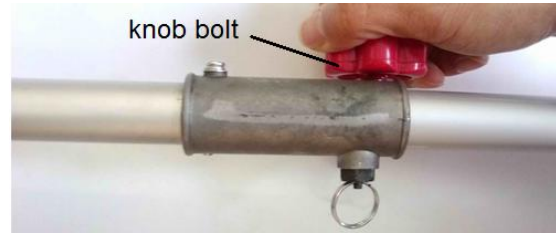
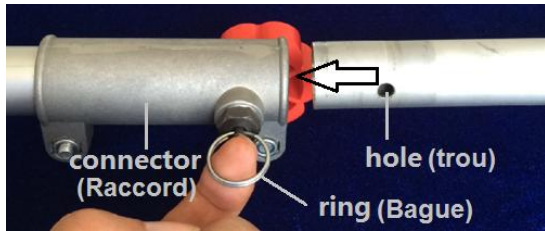

### INSTALLING HANDLE

Install handle in bracket. Position handle in a comfortable operating position and tighten four bolts.

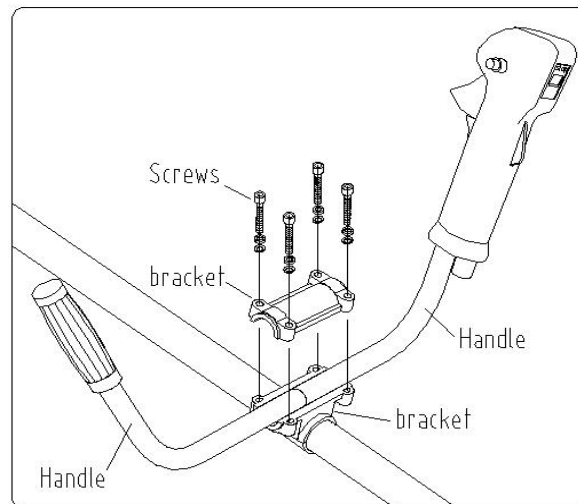

### INSTALLING THE CARTER OF PROTECTION

Install the carter of protection on the housing. Screw it with the two provided screws.



### INSTALLING NYLON LINE CUTTER HEAD (FOR GRASS TRIMMING)

- Align hole of the upper plate with hole in shaft and put a locking tool (such as a wrench).  
Remove the locking nut and the lower plate.  
Install the line cutter head by turning it counter clockwise until it is tight.  
Remove locking tool.

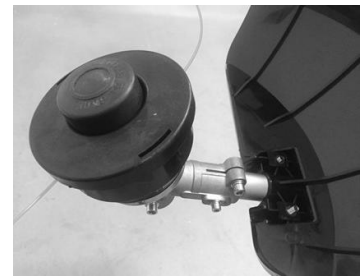
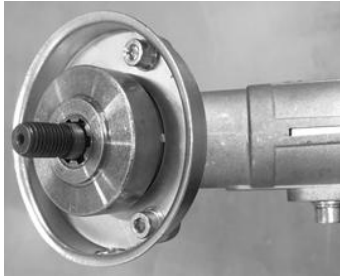

To remove the cutting head, put a locking tool in the hole of the shaft. Then unscrew the cutting head. This will have to be done tool off and cooled.

### **INSTALLING THE METAL BLADE (FOR BRUSHCUTTING)**

**When installing and removing the blade, pay attention to its sharp edges. Wear protective gloves.**

Align hole of the upper plate with hole in shaft and put a locking tool (such as a wrench).

Remove the locking nut and the lower plate.

Install the blade on the upper plate

Install the lower plate. Then, screw the locking nut to secure the installation.

Do the inverse steps to remove the blade.

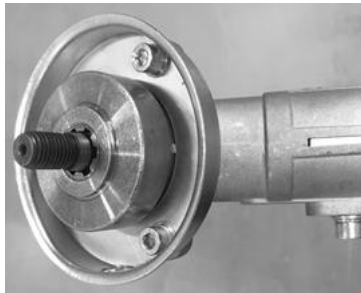

### **INSTALLING THE SHOULDER STRAP**

Hang the harness in its dedicated location on the tube. Adjust the size of the harness properly to have a correct working position.



**Please do not use both functions at the same time. Before using the tool, check that the tubes, cutting accessories and the harness are properly installed.**

## **4. OPERATION**

### **RULES FOR SAFE OPERATION**

**WARNING**  **DANGER**

All models trimmers and brush cutters can throw small stone, metal or small objects as well as the material being cut. Read these "Rules for Safe Operation" with care.

Follow the instructions in your operator's manual.

- Read the operator's manual carefully. Be thoroughly familiar with the controls and proper use of the unit. Know how to stop the unit and shut off the engine. Know how to unhook a harnessed unit quickly.
- Never allow anyone unit without proper instruction. Be sure the operator wears the foot, leg, eye, face and hearing or thrown objects. Keep the area clear of bystanders, children and pets. Never allow children to operate or play with the unit.
- Do not allow anyone to enter the operating DANGER ZONE with you. The danger zone is an area 15 meters in radius (about 16 paces) or 50 feet.
- Insist that persons in the RISK ZONE beyond the danger zone wear eye protection from thrown objects. If the unit must be used where there are unprotected people, operate at a low throttle speed to reduce the risk of thrown objects.
- Move the stop switch to "o" position when the engine idles, insure it reliable before cutting. Only may continue to operate the unit when stop switch is in good condition.
- Routines for checking that the cutting attachment stops turning when the engine idles.

**WARNING  DANGER**

In addition to head, eye, face and ear protectors shoes to protect your feet improve your footing on slippery surfaces. Do not wear ties, jewelry, or loose, dangling clothing which could be caught in the unit.

Do not wear open-toed footwear, or go bare-foot or bare legged. In certain situations you must wear total face and head protection.

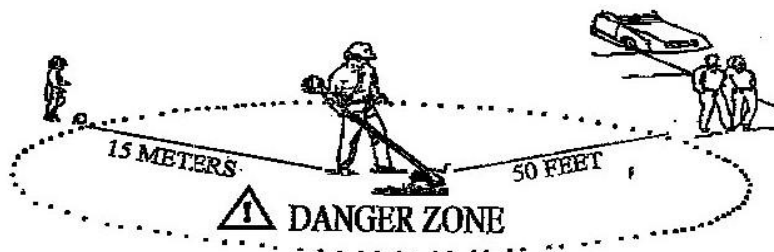

** DANGER ZONE**

NO PERSON EXCEPT OPERATOR ALLOWED 15 METERS RADIUS DANGER ZONE. EYE, EAR, FACE, FOOT, LEG AND BODY PROTECTION MUST BE WORN BY OPERATOR. PERSONS IN ZONE OR RISK BEYOND DANGER ZONE SHOULD WEAR EYE PROTECTION AGAINST THROWN OBJECTS. RISK DIMINISHES WITH DISTANCE FROM DANGER ZONE.

## CUTTING WITH A NYLON HEAD

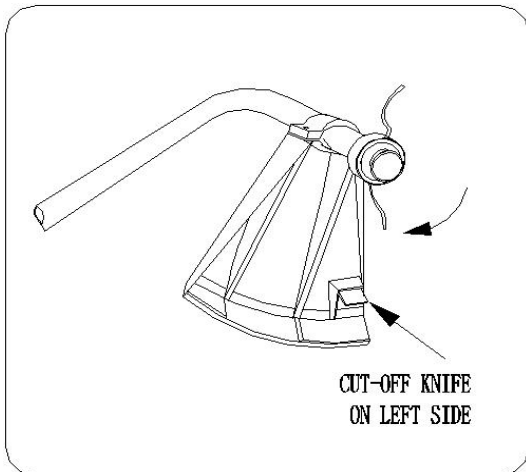

### WARNING DANGER

The proper debris shield must be in place on the unit when nylon cutting line is used. The cutting line can flap around if too much line is exposed. Always use the plastic debris shield with cut-off knife when using nylon cutting heads.

For nearly all cutting, it is good to tilt the line head so that contact is made on the part of the line circle where the line is moving A W A Y from you and the debris shield. (See appropriate) This results in the debris being thrown A W A Y from you.

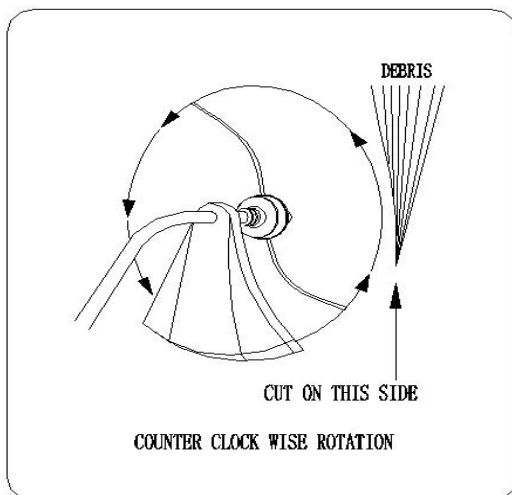

### WARNING DANGER

Tilting the head to the wrong side will shoot the debris TOWARDS you. If the line head is held flat to the ground so that cutting occurs on the whole line circle, debris will be THROWN at you, drag will slow the engine down, and you will use up a lot of line.

### WARNING DANGER

Use only quality nylon monofilament line of the diameter 2.5mm. Never use wire or wire-reinforced line in place of nylon trimmer line. Load your nylon line cutting head only with nylon trimmer line of the proper diameter.

### WARNING DANGER

Use extreme caution when operating over bare spots and gravel, because the line can throw small rock particles at high speeds. Debris shields on the unit cannot stop objects which bounce or ricochet off hard surfaces.

## CUTTING WITH A NYLON HEAD

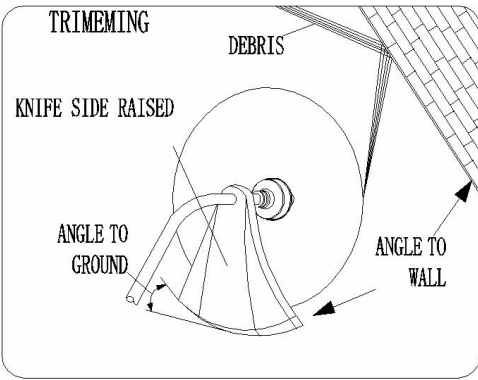

### TRIMMING:

This is feeding the trimmer carefully into the material you wish to cut. Tilt the head slowly to direct debris away from you. If cutting up to a barrier such as fence, wall or tree, approach from an angle where any debris ricocheting off the barrier will fly away from you. Move the line head slowly until the grass is cut right up the barrier, but do not jam (overfeed) the line into the barrier. If trimming up to a wire mesh or chain linked fence be careful to feed only up to wire. If you go to far the line will snap off around the wire. Trimming can be done to cut through weed stems one at a time. Place the trimmer line head near the bottom of the weed-never high up which could cause the weed to chatter and catch the line. Rather than cut the weed right through, just use the very end of the line to wear through the stem slowly.

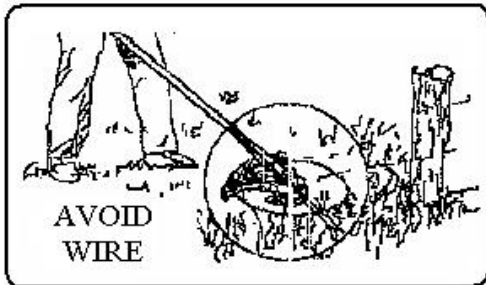
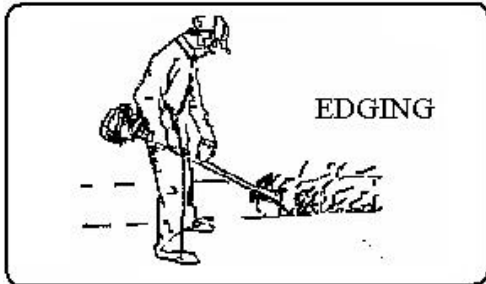
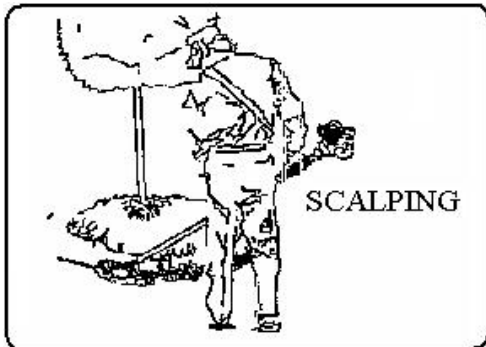

**WARNING**  **DANGER**

Do not to use a steel blade for edging or scalping.

### SCALPING AND EDGING:

Both of these are done with the line head tilted at a steep angle. Scalping is removing top growth leaving the earth bare.

Edging is trimming the grass back where it has spread over a sidewalk or drive way. During both edging and scalping, hold the unit a steep angle and in a position where the debris, and any dislodging dirt and stones, will not come back towards you even if it ricochets off the hard surface. Although the picture shows how to edge and scalp every operator must find for himself the angles which suits his body size and cutting situation.

**WARNING**  **DANGER**

Do not trim in any area where there are strands of fencing wire. Wear protective safety protecting , Do not cut where you cannot see what the cutting device is cutting.

## CUTTING WITH A BLADE

3-tooth metal blade metal blade are provided with the machine

The **metal blade** is used for cutting brush and weeds up to 3/4" in diameter.

Use of saw blade with this machine is prohibited.

**WARNING**  **DANGER**  
**DO NOT USE A BRUSH CUTTER  
FOR CUTTING TREES.**

**WARNING**  **DANGER**  
Use the shoulder harness at all times adjust both harness and harness clamp on the unit so that the unit hangs a few inches above ground level .The cutting head and the debris shield should be level in all directions. Harness the unit on the right side of your body.

**WARNING**  **DANGER**  
Do not cut with dull, cracked or damaged meal blade.  
Before cutting growth, inspect for obstructions such as boulders, metal stakes or strands of wire from broken fences. If an obstruction can not be removed, mark its location so that you can avoid it with the blade. Rocks and metal will dull or damage a blade. Wire can catch on the blade head and flap around or be thrown into the air.

## CUTTING WITH A BLADE

SCYTHING WEEDS. This is cutting by swinging the blade in a level arc. It can quickly clear areas of field grass and weeds. Scything should not be used to cut large, tough weeds or woody growths.

### NOTE:

**Do not use a brush blade to cut trees which exceed a diameter of 1/2 to 3/4 inches.**

Scything can be done in both directions, or just in one way which results in the debris being thrown away from you.

That is using the side of the blade that it is rotating away from you. Tilt down the blade slightly on this same side. You will be hit by some debris if you scythe in both directions.

Cut only with the side of the blade that the debris is moving away from you.

If kickback occurs, the blade may be dull, or the material so thick and hard that you should use other tool instead of this machine.

Do not force the blade to cut. Do not change the angle of cut after into the wood. Avoid using any pressure or leverage which could cause the blade to bind or crack .

## FUEL & OIL MIXTURE



- Never fill the fuel tank to the very top.
- Never add fuel to the tank in a closed non-ventilated area.
- Do not add fuel to this unit close to an open fire or sparks.
- Be sure to wipe off spilled fuel before attempting to start engine.
- Do not attempt to refuel a hot engine.

Fuel used for this model is a mixture of unleaded gasoline and approved engine lubricant. When mixing gasoline with two-cycle engine oil, use only gasoline which contains NO ETHANOL or METHANOL(Types of Alcohol) Use Branded 89 octane or higher

Unleaded gasoline known to be of good quality. This will help to avoid possible damage to engine fuel lines and other engine parts.

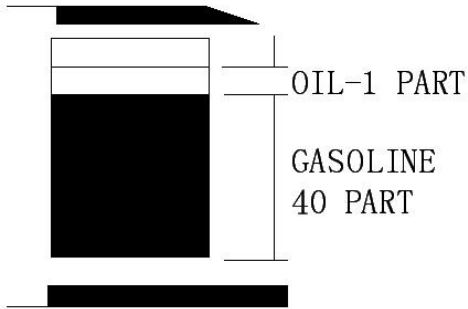

MIXTURE RATIO IS 40:1  
 GASOLINE-40PART OIL-1 PART

Fuel mixture at the rate other than 40:1 may cause damage to the engine, Ensure mixture ratio is correct.

## FUEL

The engine uses two-stroke fuel, a mixture of gasoline and 2-stroke lubricant 40:1

### IMPORTANT!

Two-stroke fuel may separate. Shake fuel container thoroughly before each use. Stored fuel ages. Do not mix more fuel than you expect to use within a month.

### GASOLINE

Use branded 89 octane or higher unleaded gasoline known to be of good quality.

### FUEL AND OIL MIXTURE

Inspect fuel tank making sure that it is clean and fill with fresh fuel. Use a mixture of 40:1

### STORING FUEL

Store fuel only in a clean, safe, approved container. Check and follow local ordinances. on type and location of storage container.

## PREPARING FOR OPERATIONS

WHEN MIXING GASOLINE WITH TWO CYCLE ENGINE OIL, USE ONLY GASOLINE WHICH CONTAINS NO ETHANOL OR METHANOL (TYPES OF ALCOHOL). THIS WILL HELP TO AVOID POSSIBLE DAMAGE TO ENGINE FUEL LINES AND OTHER ENGINE PARTS.

DO NOT MIX GASOLINE AND OIL DIRECTLY IN THE ENGINE FUEL TANK.

**IMPORTANT:** Failure to follow proper fuel mix instructions may cause damage to the engine.

1. When preparing fuel mixture, mix only the amount needed for the job you are to do. Do not use fuel that has been stored longer than two months. Fuel mixture stored longer than this will cause hard starting and poor performance. If fuel mix has been stored longer than this time. It should be removed and filled with fresh mixture.

**WARNING**  **DANGER**

1. Never fill the fuel tank to the very top.
2. Never add fuel to the tank in a closed non-ventilated area.
3. Do not add fuel to this unit close to an open fire or sparks.
4. Be sure to wipe off spilled fuel before attempting to start engine
5. Do not attempt to refuel a hot engine.

## CHECK POINTS BEFORE OPERATION

1. Check for loose bolts. Nuts and fittings.
2. Check the air cleaner for dirt. Clean the air filter of all dirt. Etc. before operation.



3. Check to be sure that protector is securely in place.
4. Check to be sure that is not leak.
5. Check to be sure the blade is not running in idling speed.

**WARNING**  **DANGER**

The engine exhaust from this product contains chemicals known to cause cancer, birth defects, or other reproductive harm.

**OPERATIONS**

**ENGINE STARTING AND STOPPING PROCEDURES**

**1. First use and cold engine start**

1). Set the On / Off switch to the On position (I). **Pic.A**

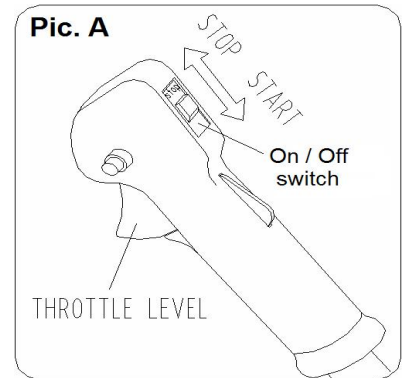

2). Put the choke in the OFF position. **Pic.B**

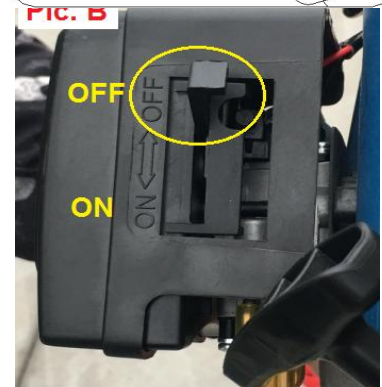

3). Press the priming pump, located under the air filter cover, about 7 to 10 times until the fuel enters the carburetor. **Pic.C**

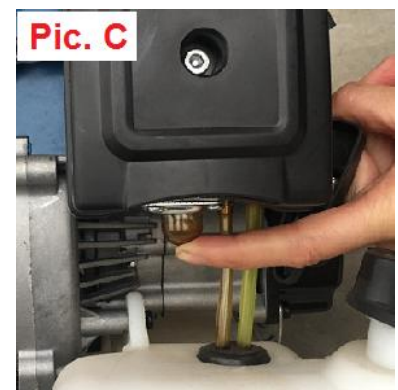

4). Pull the thrower softly until you feel a resistance, then pull with a sharp blow.

Be careful to accompany the handle to avoid a sudden return of it on the engine of the machine. **Pic.D**



5). After the machine has started, return the choke to the ON position

**Pic.E**

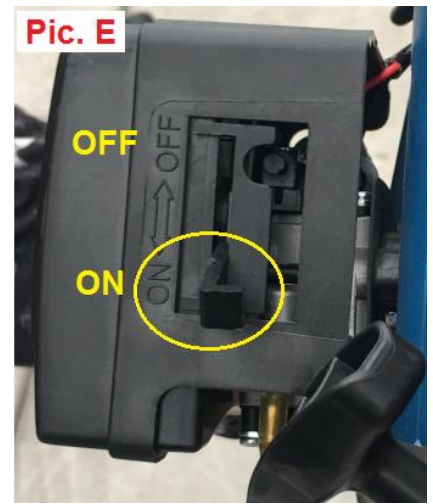

6). Allow the machine to warm up for 2-3 minutes.

## 2. Warm engine start

- 1). To restart the machine when the engine is warm, put the choke in the ON position.
- 2). Pull the starter gently until you feel a resistance, then pull with a sharp jerk.
- 3). Let the engine run until it reaches a steady state.

## 3. Stopping



**WARNING!** The cutting device may continue to run for a few seconds after stopping the machine.

- 1). Release the throttle trigger and let the engine idle.
  - 2). Turn the ON/OFF switch to the off position (O).
- If you experience unusual and excessive vibrations, stop the machine immediately. Perform the checks to determine the cause.

## 5. MAINTENANCE & STORAGE

### AIR FILTER

- Accumulated dust in the air filter will reduce engine efficiency. Increase fuel consumption and allow abrasive particles to pass into the engine. Remove the air filter as often as necessary to maintain in a clean condition.
- Light surface dust can readily be removed by tapping the filter. Heavy deposits should be washed out in suitable solvent.
- Remove filter cover by loosening air filter cover knob.

### ADJUSTING CARBURETOR

#### NOTE:

Do not adjust carburetor unless necessary. If you have trouble with the Carburetor, see your dealer. Improper adjustment may cause engine damage And void warranty.

### FUEL FILTER

- Fuel tank is fitted with a filter. Filter is situated at the free end of fuel pipe and can be picked out through fuel port with a piece of hooked wire or The like.
- Check the fuel filter periodically. Do not allow dust to enter into fuel tank. Clogged filter will cause difficulty in starting engine or abnormalities in starting engine or abnormalities in engine performance.
- When filter is dirty, replace the filter.
- When the inside of the fuel tank is dirty, it can be cleaned by rinsing the tank out with gasoline.

### CHECK SPARK PLUG

- Do not attempt to remove the plug from a hot engine in order to avoid possible damage to the threads.

### TROUBLE SHOOTING

- Clean or replace the plug if fouled with heavy oily deposits.
- Replace the plug if the center electrode is worn rounded at the end.
- Spark gap 0.6-0.7mm (.023".028")
- Fastening torque = 145-155kg.cm (125-135in.lb)

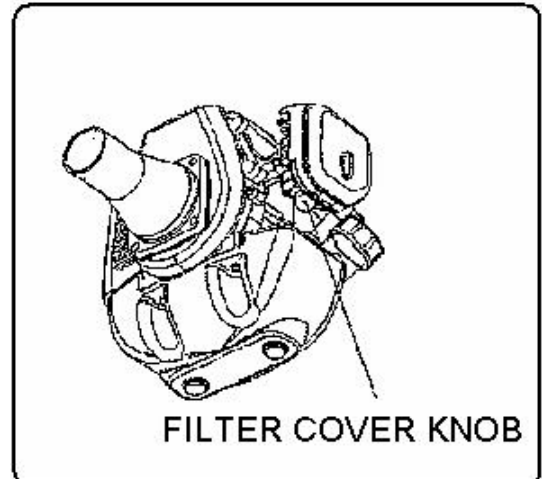

FILTER COVER KNOB

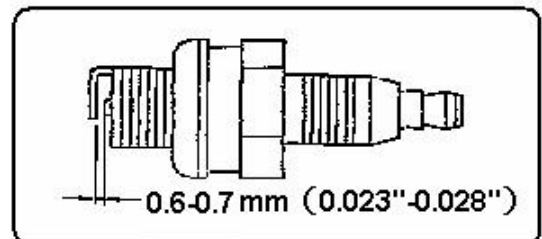
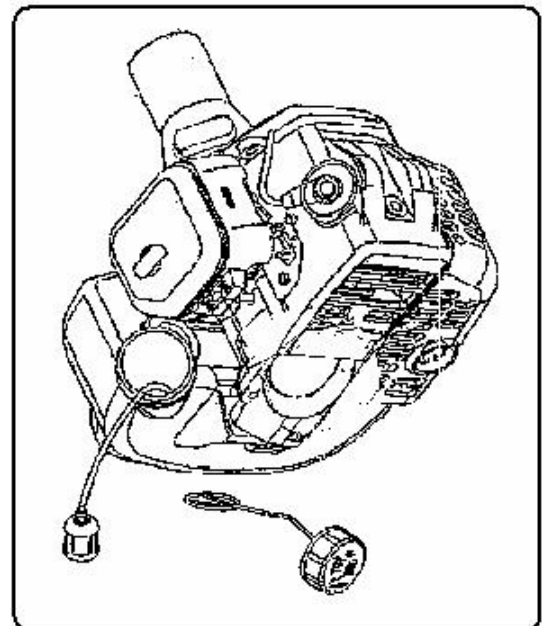

**WARNING:** Always cover the metal blade with the transportation guard while transportation and storage.

#### TRANSPORT, HANDLING

- The engine should be turned off when the unit is moved between work areas.
- After the engine has stopped, the muffler is still hot. Never touch hot parts such as the muffler.
- Confirm that the fuel is not leaked from tank.

#### EXTENDED STORAGE

- Inspect, clean and repair unit if necessary.
- Remove all fuel from tank.
- Start engine-This will consume all fuel in fuel line and carburetor.
- Remove spark plug and pour one tea spoon of clean motor oil into spark plug hole of cylinder-replace spark plug.
- Store in clean, dry, dust free area.

FAILURES such as difficulty in starting engine, irregularity in functions and abnormality in performance can normally be prevented if careful attention is paid to all operating instructions and maintenance procedures.

Should the engine not function properly, check the following;

- That the fuel system is in good condition and fuel is flowing to the engine.
- The ignition system is in good condition and the spark plug, sparks correctly;
- Compression of the engine is adequate.

#### FAILURE TO START

- Dispose of fuel in tank.
- Insure that fuel is fresh and clean.
- Check fuel filter to make sure it is clean. (Replace filter if necessary).
- Make sure air filter elements are clean.
- Install new, properly gapped spark plug.
- When there is serious trouble with the unit, do not try to repair it yourself but have your distributor or dealer do it for you.

# 6. TROUBLESHOOTING

## 1. FAILURE TO START

symptom			probable cause	remedy	
cylinder	spark plug	Fuel system abnormality	These is no fuel in tank Fuel filter obstruct	Add fuel in tank Clean fuel filter	
	spark normal	fuel system normal	fuel	Fuel is too dirty There is water in fuel There is too much Mixture ratio is improper	Instead fuel Instead fuel Tear down spark plug and dry it Mixture peroration
compress pressure	fuel system	high voltage wire spark normal	spark plug	spark plug fouled with oily deposits Spark plug insulation damage Spark gap is too large or small	Clean the oil deposits Replace spark plug Adjust spark gap 0.6-0.7mm
		normal	High voltage Spark abnormality	High voltage wire breach or break off  Coil looseness	Replace or tighten  Tighten
fuel system normal	Ignition System	compress press is shortage	piston ring attrite piston ring is broken piston ring cementation spark plug looseness conjoint surface of the cylinder and crank cast leak	replace a new replace eliminate tighten eliminate	
	normal	Compress normal	High voltage wire and spark Plug contact badness  Stop switch failure or short circuit	tighten the spark plug cap  repair or replace	

## 2. LOW OUTPUT

symptom	probable cause	remedy
flameout when speedup  the smoke is thin, carburetor spout backward	fuel filter obstruct, fall short of fuel muffler fouled with oily deposits	clean fuel filter 、 clean fuel road、 adjust carburetor clean the oily deposits
compress press is shortage	piston、 piston ring、 cylinder attrite、	replace piston、 piston ring
engine leak	Conjoint surface of the Cylinder and crank cast leak	repair
the end of two crank shaft leak	the seal is bad	replace seal
	engine overheats  burning room fouled with oily deposits	avoid use it for long time、 high speed and heavy load clean the oily deposits

## 3. ENGINE RUNNING UNSTABLE

symptom	probable cause	remedy
there are metal knock sound	piston、 piston ring、 cylinder attrite、 piston pin、 piston attrite bearing of crank shaft attrite	replace piston、 piston ring  replace piston pin、 piston replace bearing
there are metal knock sound	engine overheats  burning room fouled with oily deposits gasoline branded is unfit	avoid use it for long time、 high speed and heavy load clean the oily deposits  replace require branded octane
engine ignition break off	there is water in fuel spark gap is wrong coil gap is wrong	instead fuel adjust spark gap 0.6-0.7mm adjust coil gap 0.3-0.4mm

## 4. THE ENGINE SUDDENLY STOPPED

probable cause	remedy
fuel is use up spark plug fouled with oily deposits and short circuit high voltage wire fall off	add fuel clean the oily deposits connect

# 7. DECLARATION OF CONFORMITY



**BUILDER SAS**

ZI, 32 rue aristide Bergès – 31270 Cugnaux - France  
Tel : +33 (0)5.34.502.502 Fax : +33 (0)5.34.502.503

declares that the machines:

**GASOLINE BRUSH CUTTER & GRASS TRIMMER**  
**Model: RAC52PB-C**

**Serial No.: 20241101201-20241103346**

have been designed in compliance with the following standards:

EN ISO 11806-1: 2022

EN ISO 14982:2009

EN ISO 3744:1995 & ISO 10884:1995

And in accordance with the following directives:

Directive Machine 2006/42/EC

Directive EMC 2014/30/EU

noise Directive 2000/14/EC Annex V & Directive 2005/88/EC  
emission directive 2016/1628/EU & 2018/989/EU

Measured sound power level L<sub>WA</sub>  
(According to ISO 22868)

Brush cutter: 107 dB (A)  
Grass trimmer: 108 dB (A)  
K=3 dB (A)

Guaranteed sound power level  
(According to ISO 2000/14/EC)

115 dB (A)

The people name holding the technical file: Mr.Olivier Patriarca

Philippe MARIE / PDG  
Cugnaux, 08-08-2024

## 8. WARRANTY



### WARRANTY

The manufacturer guarantees the product against defects in material and workmanship for a period of 2 years from the date of the original purchase. The warranty only applies if the product is for household use. The warranty does not cover breakdowns due to normal wear and tear.

The manufacturer agrees to replace parts identified as defective by the designated distributor. The manufacturer does not accept responsibility for the replacement of the machine, in whole or in part, and/or ensuing damage.

**The warranty does not cover breakdowns due to:**

- insufficient maintenance.
- abnormal assembly, adjustment or operations of the product.
- parts subject to normal wear and tear.

**The warranty does not extend to:**

- shipping and packaging costs.
- using the tool for a purpose other than that for which it was designed.
- the use and maintenance of the machine done in a manner not described in the user manual.

Due to our policy of continuous product improvement, we reserve the right to alter or change specifications without notice. Consequently, the product may be different from the information contained therein, but a modification will be undertaken without notice if it is recognized as an improvement of the preceding characteristic.

**READ THE MANUAL CAREFULLY BEFORE USING THE MACHINE.**

When ordering spare parts, please indicate the part number or code, you can find this in the spare parts list in this manual. Keep the purchase receipt; without it, the warranty is invalid. To help you with your product, we invite you to contact us by phone or via our website:

- **+33 (0)9.70.75.30.30**
- **<https://services.swap-europe.com/contact>**

You must create a "ticket" via the web platform.

- Register or create your account.
- Indicate the reference of the tool.
- Choose the subject of your request.
- Describe your problem.
- Attach these files: invoice or sales receipt, photo of the identification plate (serial number), photo of the part you need (for example: pins on the transformer plug which are broken).





# 9. PRODUCT FAILURE

## WHAT TO DO IF MY MACHINE BREAKS DOWN?

### **If you bought your product in a store:**

- a) Empty the fuel tank if your product has one.
- b) Make sure that your machine is complete with all accessories supplied, and clean! If this is not the case, the repairer will refuse the machine.

Go to the store with the complete machine and with the receipt or invoice.

### **If you bought your product on a website:**

- a) Empty the fuel tank if your product has one.
- b) Make sure that your machine is complete with all accessories supplied, and clean! If this is not the case, the repairer will refuse the machine.
- c) Create a SWAP-Europe service ticket on the site: <https://services.swap-europe.com> When making the request on SWAP-Europe, you must attach the invoice and the photo of the nameplate (serial number).
- d) Contact the repair station to make sure it is available before dropping off the machine.

Go to the repair station with the complete machine packed, accompanied by the purchase invoice and the station support sheet downloadable after the service request is completed on the SWAP-Europe site

For machines with engine failure from manufacturers BRIGGS & STRATTON, HONDA and RATO, please refer to the following instructions.

Repairs will be done by approved engine manufacturers of these manufacturers, see their site:

- <http://www.briggsandstratton.com/eu/fr>
- <http://www.honda-engines-eu.com/fr/service-network-page;jsessionid=5EE8456CF39CD572AA2AEEDFD290CDAE>
- <https://www.rato-europe.com/it/service-network>

**Please keep your original packaging to allow for after-sales service returns or pack your machine with a similar cardboard box of the same dimensions.**

**For any question concerning our after-sales service you can make a request on our website <https://services.swap-europe.com>**

**Our hotline remains available at +33 (9) 70 75 30 30.**



# 10. WARRANTY EXCLUSIONS

## THE WARRANTY DOES NOT COVER:

- Start-up and setting up of the product.
- Damage resulting from normal wear and tear of the product.
- Damage resulting from improper use of the product.
- Damage resulting from assembly or start-up not in accordance with the user manual.
- Breakdowns related to carburetion beyond 90 days and fouling of carburetors.
- Periodic and standard maintenance events.
- Actions of modification and dismantling that directly void the warranty.
- Products whose original authentication marking (brand, serial number) has been degraded, altered or withdrawn.
- Replacement of consumables.
- The use of non-original parts.
- Breakage of parts following impacts or projections.
- Accessories breakdowns.
- Defects and their consequences linked to any external cause.
- Loss of components and loss due to insufficient screwing.
- Cutting components and any damage related to the loosening of parts.
- Overload or overheating.
- Poor power supply quality: faulty voltage, voltage error, etc.
- Damages resulting from the deprivation of enjoyment of the product during the time necessary for repairs and more generally the costs related to the immobilization of the product.
- The costs of a second opinion established by a third party following an estimate by a SWAP-Europe repair station
- The use of a product which would show a defect or a breakage which was not the subject of an immediate report and/or repair with the services of SWAP-Europe.
- Deterioration linked to transport and storage\*.
- Launchers beyond 90 days.
- Oil, petrol, grease.
- Damages related to the use of non-compliant fuels or lubricants.

\* In accordance with transport legislation, damage related to transport must be declared to carriers within 48 hours maximum after observation by registered letter with acknowledgement of receipt.

This document is a supplement to your notice, a non-exhaustive list.

**Attention:** all orders must be checked in the presence of the delivery person. In case of refusal by the delivery person, it you must simply refuse the delivery and notify your refusal.

**Reminder:** the reserves do not exclude the notification by registered letter with acknowledgement within 72 hours.

**Information:** Thermal devices must be wintered each season (service available on the SWAP-Europe site). Batteries must be charged before being stored.



BUILDER SAS  
32 rue Aristide Bergès - Z.I. du Casque - 31270 Cugnaux - France  
MADE IN PRC